

Enbrighten Zigbee In-Wall Tamper-Resistant Smart Outlet

enbrighten®



Specifications

Power: 120VAC, 60Hz **Signal Frequency:** 2.4GHz

Maximum Load for the Zigbee-Controlled Outlet:

1000W incandescent, 1/2 HP motor or 1800W resistive(15A) or 3.75A LED/CFL

Range: Up to 150ft. from controller or closest Zigbee device

Operating Temperature: 32-104° F (0-40° C)

Warranty: 5-year limited product warranty

For indoor use only

Design Features

- Turn ON/OFF manually or remotely via the Zigbee controller
- Can be included in multiple groups and scenes
- Over-the-air updates – once joined to your Zigbee network, the smart outlet can automatically receive updates through your Zigbee gateway
- Blue LED indicates smart outlet location in a dark room (LED can be enabled/disabled manually)
- LED status indicator – indicates smart outlet scanning during pairing process
- Zigbee 3.0 certified for simple pairing and integrated home automation
- Screw terminal installation – requires wiring connections for line (hot), neutral and ground

Zigbee Plus Features

- Effortless device pairing to Zigbee certified gateways
- Backward compatible with all generations of Zigbee devices
- Supports wireless upgrades to future-proof your home

* Requires Zigbee hub or controller – functions may vary depending on brand.

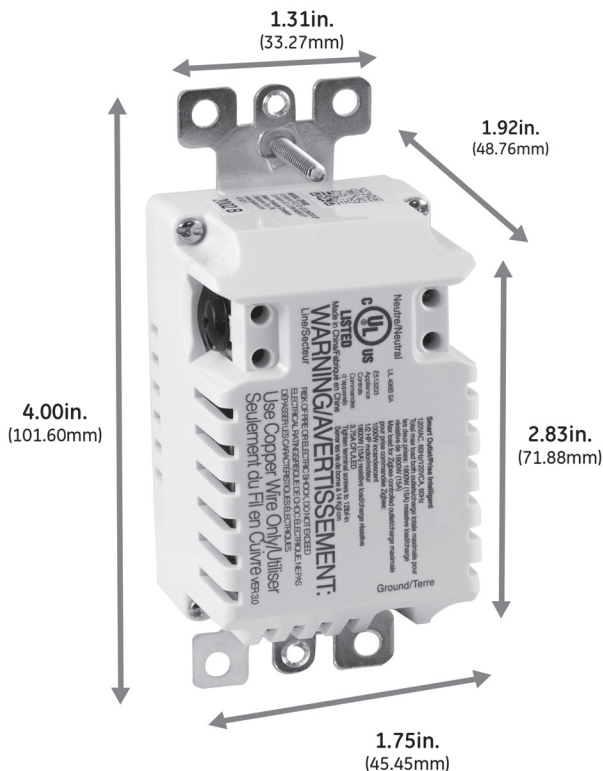

Wiring

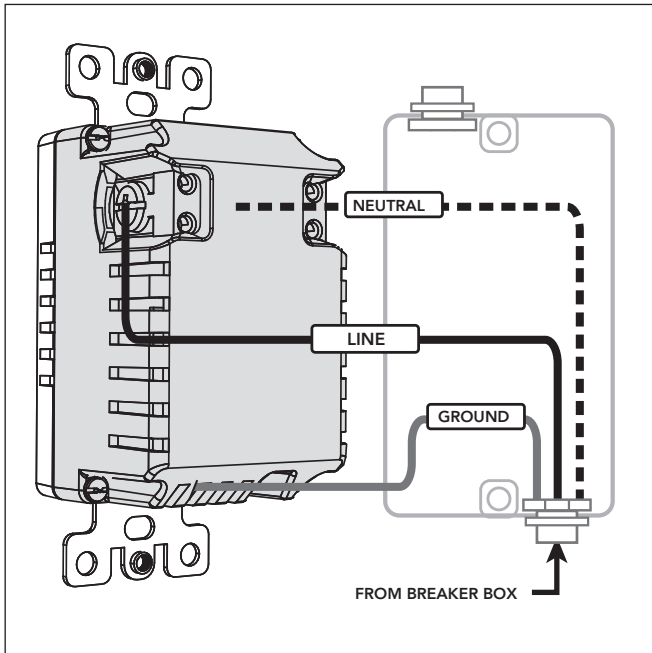

Space-Saving Screw Terminals

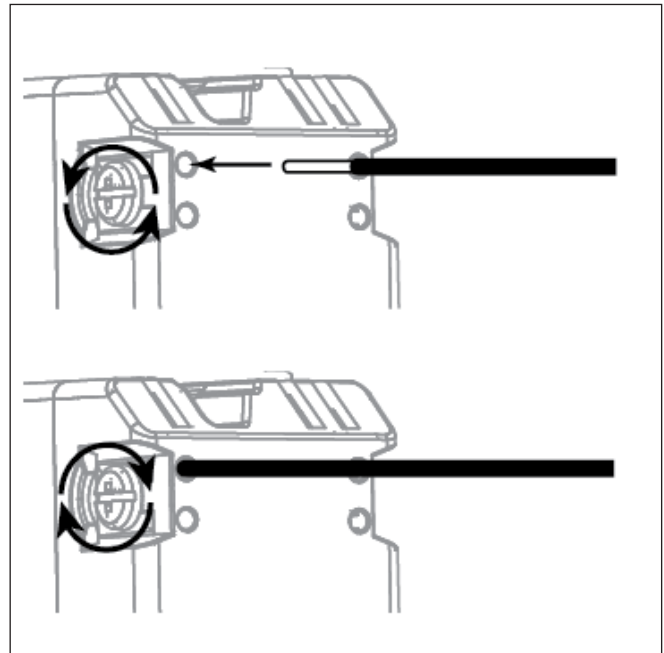

Two Outlets

Contains one grounded Zigbee-controlled AC outlet and one standard grounded AC outlet.



Tamper Resistant

Prevents objects from being forcibly inserted into a single slot.

- Improves child safety
- Prevents injuries associated with electrical receptacles
- Meets National Electric Code (NEC) requirements
- UL listed

Installation Recommendations

- Devices require a single-gang U.S. wall box – 3½in. deep recommended, 2¼in. deep minimum
- Insert wires into holes, do not wrap wires around screws. Do not remove screws.
- Indoor installation only
- Visit ezzigbee.com/hubs for hub compatibility
- Wallplates sold separately
- Trilingual instruction manual – English, French, Spanish

Device Configuration

Adding your devices to a Zigbee network

Once the hub is ready to add the smart outlet, pairing begins automatically when power is supplied. The outlet appears in the controller’s menu when paired.

To remove and reset the device

Choose to remove the device as instructed by your hub. The controller indicates the smart outlet was removed.

To return to factory defaults

Quickly press the program button three times and hold the button for at least three seconds.

Certifications & Compliances













Compliances, specifications and availability are subject to change without notice

Distributed by Jasco Products Company LLC
10 E. Memorial Rd., Oklahoma City, OK

©Jasco 2020

Related Products – Enbrighten Zigbee Smart Controls

- | | | | | | | | | |
|--|---|---|---|---|--|---|---|--|
|  |  |  |  |  |  |  |  | |
| 43094
Plug-In
Dual-Outlet
Smart Switch | 43096
Plug-In
Dual-Outlet
Smart Dimmer | 43100
Plug-in
Outdoor
Smart Switch | 43076
In-Wall
Smart Switch,
Paddle | 43077
In-Wall
Smart Switch,
Paddle 120/277 | 43080
In-Wall
Smart Dimmer,
Paddle | 43084
In-Wall Smart
Switch, Toggle | 43090
In-Wall
Smart Dimmer,
Toggle | |
|  |  | | | | | | | |
| 46199
In-Wall Add-on
Switch, Paddle | 46200
In-Wall Add-On
Switch, Toggle | | | | | | | |